

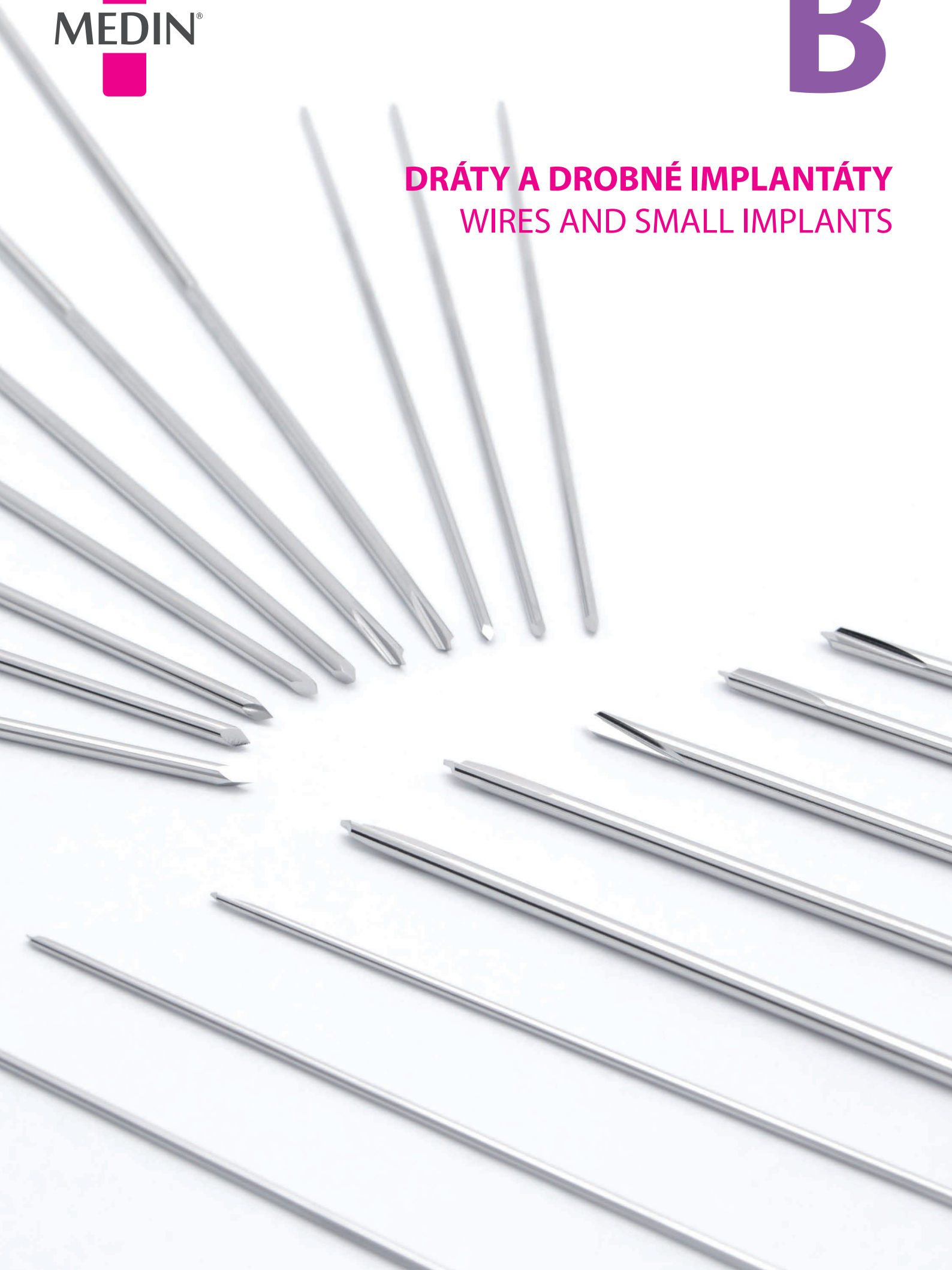

B

DRÁTY A DROBNÉ IMPLANTÁTY
WIRES AND SMALL IMPLANTS





MEDIN, a.s.
Vlachovická 619
Nové Město na Moravě
CZ 592 31
Czech Republic
IČO 43378030
DIČ CZ43378030

PRODEJ ČESKÁ REPUBLIKA

tel.: 566 684 327
fax: 566 684 384
e-mail: prodej@medin.cz

EXPORT

phone: +420 566 684 371
fax: +420 566 684 385
e-mail: export@medin.cz

www.medin.cz
www.medin.eu

Dráty

Kirschnerovy dráty

K-dráty

Dráty kostní

Instrumentárium pro dráty

Drobné implantáty

Svorky kostní

Instrumentárium pro svorky kostní

Wires

Kirschner wires

K-wires

Bone wires

Instruments for wires

Small implants

Bone staples

Instruments for bone staples

B.1

1

2-3

4

4

B.2

1-2

2

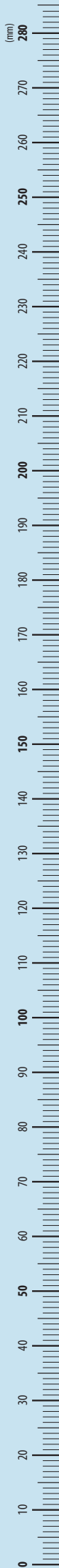

POUŽITÉ ZKRATKY A SYMBOLY

- SSt provedení SSt – materiál: nerezová ocel, dle ISO 5832-1
- Ti provedení TITAN – materiál: Ti6Al4V ELI, dle ISO 5832-3
- ∅ průměr
- ⬡ šestihran

USED ABBREVIATIONS AND SYMBOLS

- SSt SSt version – material: stainless steel, in accordance with ISO 5832-1
- Ti TITANIUM version – material: Ti6Al4V ELI, in accordance with ISO 5832-3
- ∅ diameter
- ⬡ hexagon

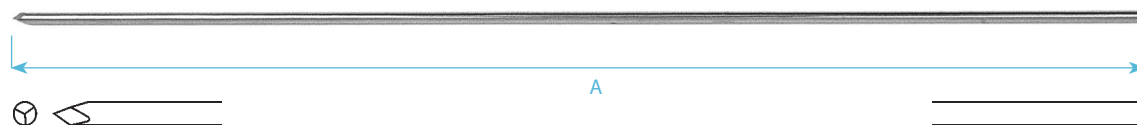
Kirschnerův drát
Kirschner wire

SSt	A	Ø
129 09 2920	160 mm	0,8 mm
129 09 3140	160 mm	1,0 mm
129 09 3070	160 mm	1,2 mm
129 09 3080	160 mm	1,5 mm
129 09 3090	160 mm	1,8 mm
129 09 3100	160 mm	2,0 mm
129 09 3110	160 mm	2,5 mm
129 09 3120	160 mm	3,0 mm
129 09 2930	200 mm	0,8 mm
129 09 3130	200 mm	3,0 mm
129 09 2960	300 mm	0,8 mm
129 09 2970	300 mm	1,0 mm
129 09 2980	300 mm	1,2 mm
129 09 3000	300 mm	1,5 mm
129 09 3010	300 mm	1,8 mm
129 09 3030	300 mm	2,0 mm
129 09 3040	300 mm	2,2 mm
129 09 3050	300 mm	2,5 mm
129 09 3060	300 mm	3,0 mm
129 09 3150	400 mm	4,0 mm

Balení 10 ks
Packing 10 pcs

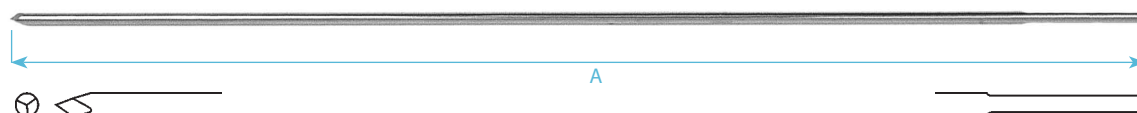
Kirschnerův drát s ploškou
Kirschner wire with flat

SSt	A	Ø
129 09 3071	160 mm	1,2 mm
129 09 3081	160 mm	1,5 mm
129 09 3091	160 mm	1,8 mm
129 09 3101	160 mm	2,0 mm
129 09 3111	160 mm	2,5 mm
129 09 3121	160 mm	3,0 mm
129 09 3131	200 mm	3,0 mm
129 09 2981	300 mm	1,2 mm
129 09 3001	300 mm	1,5 mm
129 09 3011	300 mm	1,8 mm
129 09 3031	300 mm	2,0 mm
129 09 3041	300 mm	2,2 mm
129 09 3051	300 mm	2,5 mm
129 09 3061	300 mm	3,0 mm

Balení 10 ks
Packing 10 pcs

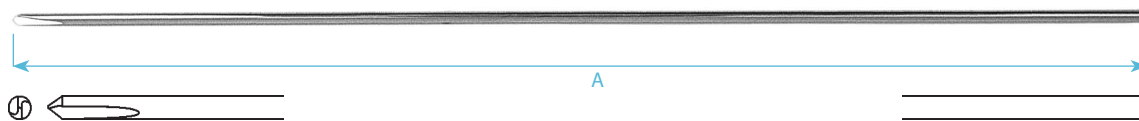
K-drát MEDIN
 K-wire MEDIN

SSt	A	Ø
129 09 2470	160 mm	1,2 mm
129 09 2480	160 mm	1,5 mm
129 09 2490	60 mm	1,8 mm
129 09 2500	160 mm	2,0 mm
129 09 2510	160 mm	2,5 mm
129 09 2520	160 mm	3,0 mm
129 09 2530	200 mm	3,0 mm
129 09 2540	300 mm	1,2 mm
129 09 2550	300 mm	1,5 mm
129 09 2560	300 mm	1,8 mm
129 09 2570	300 mm	2,0 mm
129 09 2580	300 mm	2,2 mm
129 09 2590	300 mm	2,5 mm
129 09 2600	300 mm	3,0 mm
129 09 2610	400 mm	4,0 mm

Balení 10 ks
 Packing 10 pcs



K-drát MEDIN s ploškou
 K-wire MEDIN with flat

SSt	A	Ø
129 09 2471	160 mm	1,2 mm
129 09 2481	160 mm	1,5 mm
129 09 2491	160 mm	1,8 mm
129 09 2501	160 mm	2,0 mm
129 09 2511	160 mm	2,5 mm
129 09 2521	160 mm	3,0 mm
129 09 2531	200 mm	3,0 mm
129 09 2541	300 mm	1,2 mm
129 09 2551	300 mm	1,5 mm
129 09 2561	300 mm	1,8 mm
129 09 2571	300 mm	2,0 mm
129 09 2581	300 mm	2,2 mm
129 09 2591	300 mm	2,5 mm
129 09 2601	300 mm	3,0 mm

Balení 10 ks
 Packing 10 pcs

K-drát MEDIN se závitem
K-wire MEDIN with thread

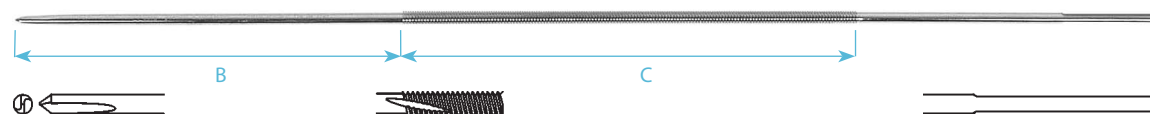
SSt	A	B	C	Ø
129 09 2740	300 mm	100 mm	100 mm	2,5 mm

 Balení 10 ks
Packing 10 pcs

K-drát MEDIN se závitem a ploškou
K-wire MEDIN with thread and flat

SSt	A	B	C	Ø
129 09 2741	300 mm	100 mm	100 mm	2,5 mm

 Balení 10 ks
Packing 10 pcs

K-drát MEDIN se zářázkou
K-wire MEDIN with stopper

SSt	A	B	C	Ø
129 77 0440	400 mm	150 mm	15 mm	1,8 mm

K-drát MEDIN se zářázkou a rýskami
K-wire MEDIN with stopper and flutes

SSt	A	B	C	Ø
129 77 0450	400 mm	150 mm	15 mm	1,8 mm

DRÁTY KOSTNÍ
BONE WIRESDrát kostní, měkký
Bone suturing wire, soft

SSt	∅	délka length
129 91 0027	0,25 mm	10 m
129 91 0029	0,3 mm	10 m
129 91 0030	0,4 mm	10 m
129 91 0031	0,5 mm	10 m
129 91 0032	0,6 mm	10 m
129 91 0033	0,7 mm	10 m
129 91 0034	0,8 mm	10 m
129 91 0035	0,9 mm	10 m
129 91 0036	1,0 mm	10 m
129 91 0037	1,2 mm	10 m
129 91 0038	1,5 mm	10 m
129 91 0039	1,8 mm	10 m
129 91 0040	2,0 mm	10 m

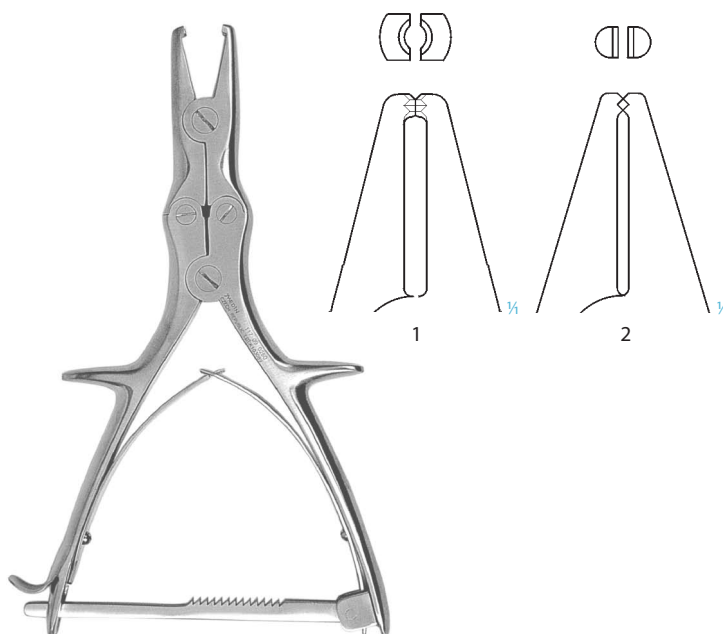
INSTRUMENTÁRIUM PRO DRÁTY
INSTRUMENTS FOR WIRES

- 1 **117 09 0260** Bartl kleště na vytažení hřebu; 215 mm
na pruty od \varnothing 2,0 mm
- 2 **117 09 0270** Bartl kleště na vytažení hřebu; 215 mm
na pruty do \varnothing 2,0 mm

Bartl nail extraction forceps; 215 mm
for nails up from \varnothing 2,0 mm
Bartl nail extraction forceps; 215 mm
for nails up to \varnothing 2,0 mm

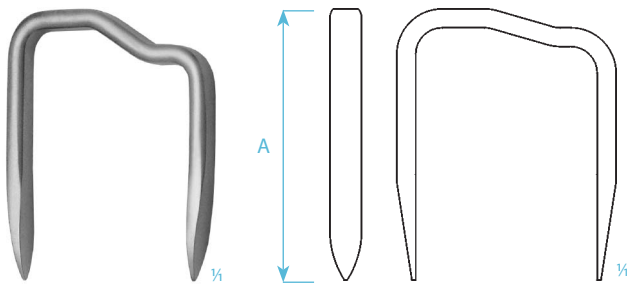
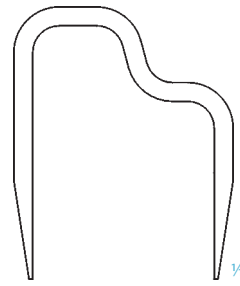
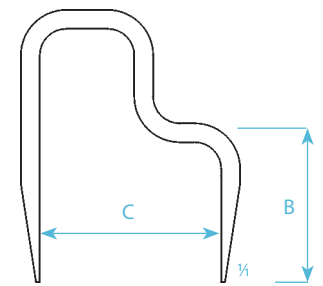
129 09 2220
 Fig. 3

129 09 2210
 Fig. 2

129 09 2200
 Fig. 1

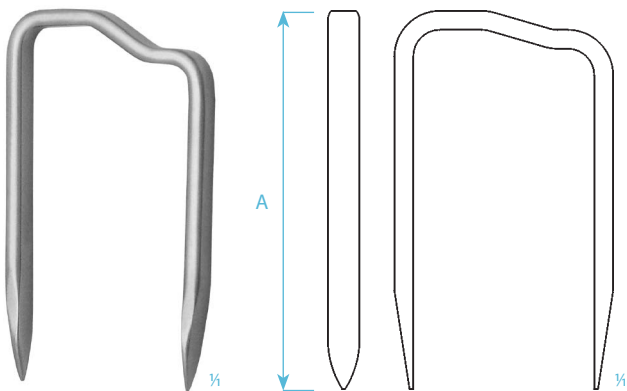
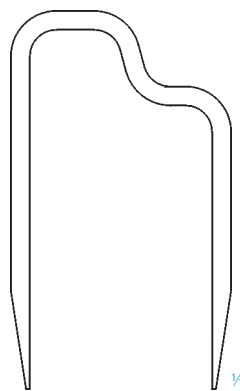
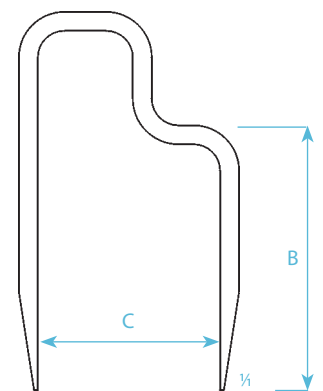
Svorka kostní, velikost 1, matovaná
Bone staple, type 1, matt

SSt	A	B	C	síla thickness
129 09 2220	34 mm	29 mm	24 mm	4,5 mm
129 09 2210	34 mm	24 mm	24 mm	4,5 mm
129 09 2200	34 mm	19 mm	24 mm	4,5 mm

129 09 2250
 Fig. 3

129 09 2240
 Fig. 2

129 09 2230
 Fig. 1

Svorka kostní, velikost 2, matovaná
Bone staple, type 2, matt

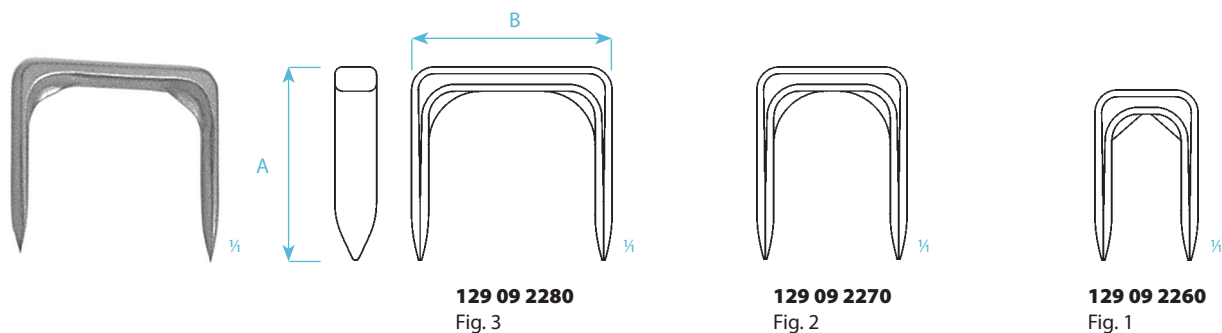
SSt	A	B	C	síla thickness
129 09 2250	50 mm	45 mm	24 mm	4,5 mm
129 09 2240	50 mm	40 mm	24 mm	4,5 mm
129 09 2230	50 mm	35 mm	24 mm	4,5 mm

Kostní svorky jsou určeny k vysoké tibiální osteotomii bérce.
 Bone staples are appointed for high tibial osteotomy of calf.

SVORKY KOSTNÍ
 BONE STAPLES

Svorka kostní, matovaná
 Bone staple, matt

SSt	A	B	síla thickness
129 09 2280	25,5 mm	26,5 mm	2,25 mm
129 09 2270	25,5 mm	20,0 mm	2,25 mm
129 09 2260	22,5 mm	13,7 mm	2,25 mm

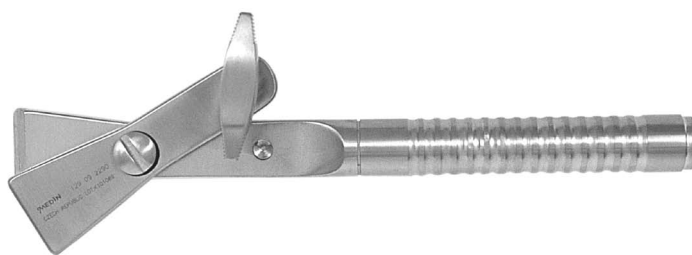
Kostní svorky jsou určeny k vysoké tibiální osteotomii bérce.
 Bone staples are appointed for high tibial osteotomy of calf.

INSTRUMENTÁRIUM PRO SVORKY KOSTNÍ
 INSTRUMENTS FOR BONE STAPLES

Zavaděč kostních svorek
 Bone staples introducer

129 09 2290	190 mm	26 mm
--------------------	--------	-------